

1 IX2B60AR
 60° connettore: zamac color argento satinato, vite acciaio inox
 60° verbinder: versilberter metall-druckguss, schraube edelstahl
 60° connector: silver-plated metal die-cast, stainless steel screw

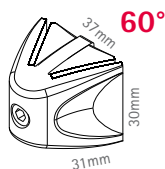

2 IX2B90AR
 90° connettore: zamac color argento satinato, vite acciaio inox
 90° verbinder: versilberter metall-druckguss, schraube edelstahl
 90° connector: silver-plated metal die-cast, stainless steel screw

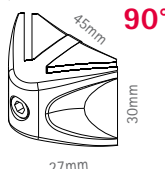

3 IX2B120AR
 135° connettore: zamac color argento satinato, vite acciaio inox
 135° verbinder: versilberter metall-druckguss, schraube edelstahl
 135° connector: silver-plated metal die-cast, stainless steel screw

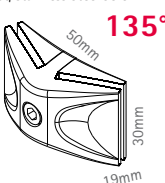

4 IX2B180AR
 180° connettore: zamac color argento satinato, vite acciaio inox
 180° verbinder: versilberter metall-druckguss, schraube edelstahl
 180° connector: silver-plated metal die-cast, stainless steel screw

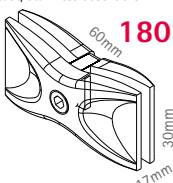

5 IX2BSWAR
 in zamac color argento per fissare pannelli a "sandwich".
 versilberter metall-druckguss für die sicherung von sandwich systemen.
 silver-plated metal die-cast for locking sandwich systems.

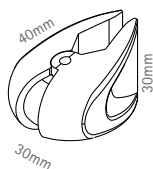

ix bond

MADE IN EU design by KD

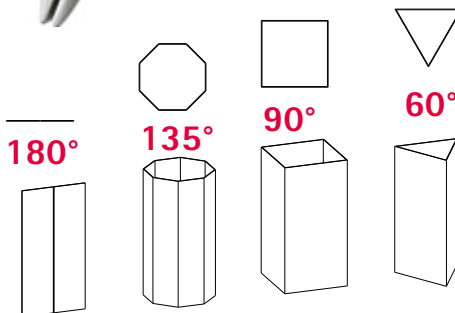
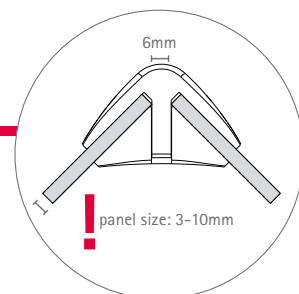

IT ixbond può connettere pannelli da 3 a 10mm con sicurezza e senza il rischio di torsioni. discreto e funzionale una volta uniti, i pannelli risulteranno a soli 6mm di distanza. la vite di chiusura è facilmente raggiungibile dal lato esterno e dal lato interno garantendo così la migliore comodità di esercizio - pratico, specialmente per strutture 3D o vicino alle pareti. ergonomici e decorativi "snodi" per montare in convenienza. cacciaviti a parte

DE ixbond verbindet paneel von 3-10mm stufenlos sicher und verwindungsstabil. die sichtfuge bleibt dabei immer dezent mit 6mm. die schraube kann beidseitig (innen wie aussen) eingesetzt werden - praktisch, wenn sie räumliche konstruktionen umsetzen oder nahe an wänden bauen. ergonomische und ästhetische griffmulden erleichtern die montage. gewünschte anzahl inbus-schlüssel bitte extra bestellen.

EN ixbond connects 3-10mm panels infinitely and free of torsion. the face joint remains at a discrete 6mm gap. the screw can be mounted from both sides. convenient if you create structures in 3-D or close to walls. ergonomic and decorative recessed grips make mounting easy. order the required keys separately.

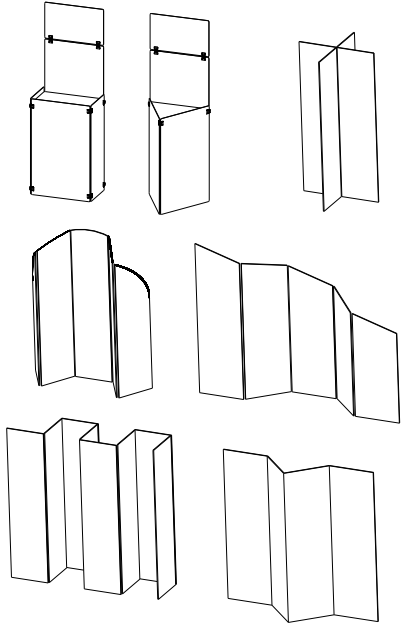

SOKEY 6
 chiave esagonale 4mm
 inbusschlüssel 4mm
 key 4mm hex ballpoint L-handle



ATPXB 7
 ix bond feltrino (spessore 1mm) per il montaggio di materiale delicato o vetro. spessore pannello: 2mm-8mm.
 ix bond buffer (1mm dick) für die befestigung von empfindlichen materialien oder glas. paneelstärke mit buffer: 2mm-8mm.
 ix bond buffer (1 mm thick) for the mounting of sensitive materials or glass. panel thickness with buffer: 2mm-8mm.



ix bond

n° articolo | artikelnr. | product nr.

1	IX2B60AR	60° connector, 1pc
2	IX2B90AR	90° connector, 1pc
3	IX2B120AR	135° connector, 1pc
4	IX2B180AR	180° connector, 1pc
5	IX2BSWAR	ixbond sandwich connector, 1pc
6	SOKEY4	t-handle hex key, 1pc
7	ATPXB	ix bond buffer, box/20pcs